

BALT[®]

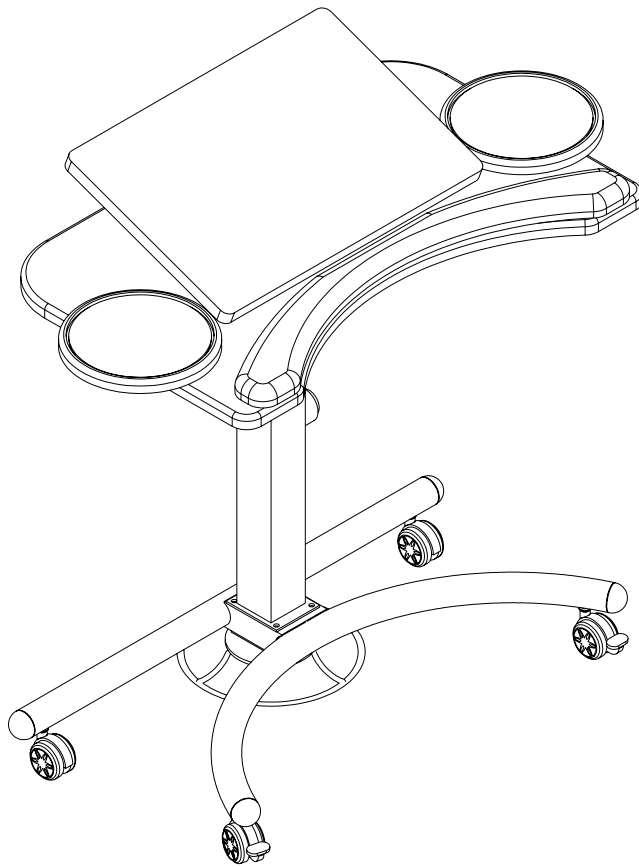









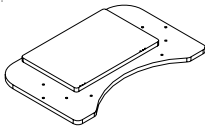



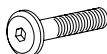

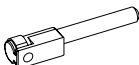
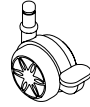





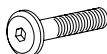

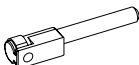
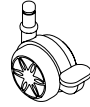



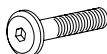

#89829 LapMatic
Laptop/Keyboard Desk

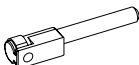
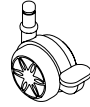

Assembly Instructions

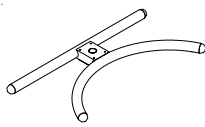
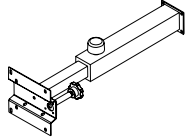
LAPMATIC

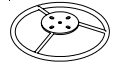
Laptop/Keyboard Desk

Part	Drawing	Description	Qty	Part	Drawing	Description	Qty																																				
P-1		Top Platform	1 EA	<h3>Hardware List</h3> <table border="0"> <tr> <td>A</td> <td></td> <td>Socket Screw M8X20 mm</td> <td>4 EA</td> </tr> <tr> <td>A1</td> <td></td> <td>Socket Screw M6X8 mm</td> <td>4 EA</td> </tr> <tr> <td>A2</td> <td></td> <td>Socket Screw M6X15 mm</td> <td>4 EA</td> </tr> <tr> <td>A3</td> <td></td> <td>Socket Screw M6X25 mm</td> <td>8 EA</td> </tr> <tr> <td>C</td> <td></td> <td>Pivot Bracket (Factory Installed)</td> <td>1 EA</td> </tr> <tr> <td>D</td> <td></td> <td>Pivot Rod w/Clip</td> <td>1 EA</td> </tr> <tr> <td>E</td> <td></td> <td>2" Locking Caster</td> <td>2 EA</td> </tr> <tr> <td>F</td> <td></td> <td>2" Caster</td> <td>2 EA</td> </tr> <tr> <td>G</td> <td></td> <td>Allen Wrench</td> <td>1 EA</td> </tr> </table>				A		Socket Screw M8X20 mm	4 EA	A1		Socket Screw M6X8 mm	4 EA	A2		Socket Screw M6X15 mm	4 EA	A3		Socket Screw M6X25 mm	8 EA	C		Pivot Bracket (Factory Installed)	1 EA	D		Pivot Rod w/Clip	1 EA	E		2" Locking Caster	2 EA	F		2" Caster	2 EA	G		Allen Wrench	1 EA
A		Socket Screw M8X20 mm	4 EA																																								
A1		Socket Screw M6X8 mm	4 EA																																								
A2		Socket Screw M6X15 mm	4 EA																																								
A3		Socket Screw M6X25 mm	8 EA																																								
C		Pivot Bracket (Factory Installed)	1 EA																																								
D		Pivot Rod w/Clip	1 EA																																								
E		2" Locking Caster	2 EA																																								
F		2" Caster	2 EA																																								
G		Allen Wrench	1 EA																																								
P-2		Mouse Platform	2 EA																																								
P-3		Base	1 EA																																								
P-4		Pneumatic Cylinder	1 EA																																								
P-5		Wrist Rest	1 EA																																								
P-6		Adjustment Wheel	1 EA																																								
P-7		Coil Spring	1 EA																																								

Missing Parts or UPS Damaged Parts
 For Your Convenience you can
 EMAIL us at
furniture@baltinc.com
 24HOURS 7 DAYS A WEEK



Tools required: Phillips Head Screw Driver

Do not use unless all screws are tight. At least every six months, check all screws to be sure they are tight. If parts are missing, broken, damaged, or worn, stop use of the product until repairs are made by your dealer using factory authorized parts.

#89829 LapMatic Assembly Diagram

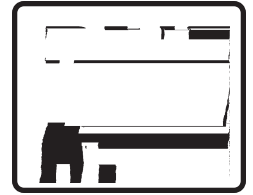

READ THROUGH INSTRUCTIONS FROM BEGINNING TO END BEFORE STARTING TO ASSEMBLE UNIT.

- 1.) Identify and Separate all the Parts and Hardware.
- 2.) Insert 2 Locking Casters (E) and 2 Casters (F) into Leg Base (P-3) as shown in illustration # 1.
- 3.) Place 1 Coil Spring (P-7) over hole and attach adjustment Wheel (P-6) using 4 each screws (A) as shown in illustration # 1.

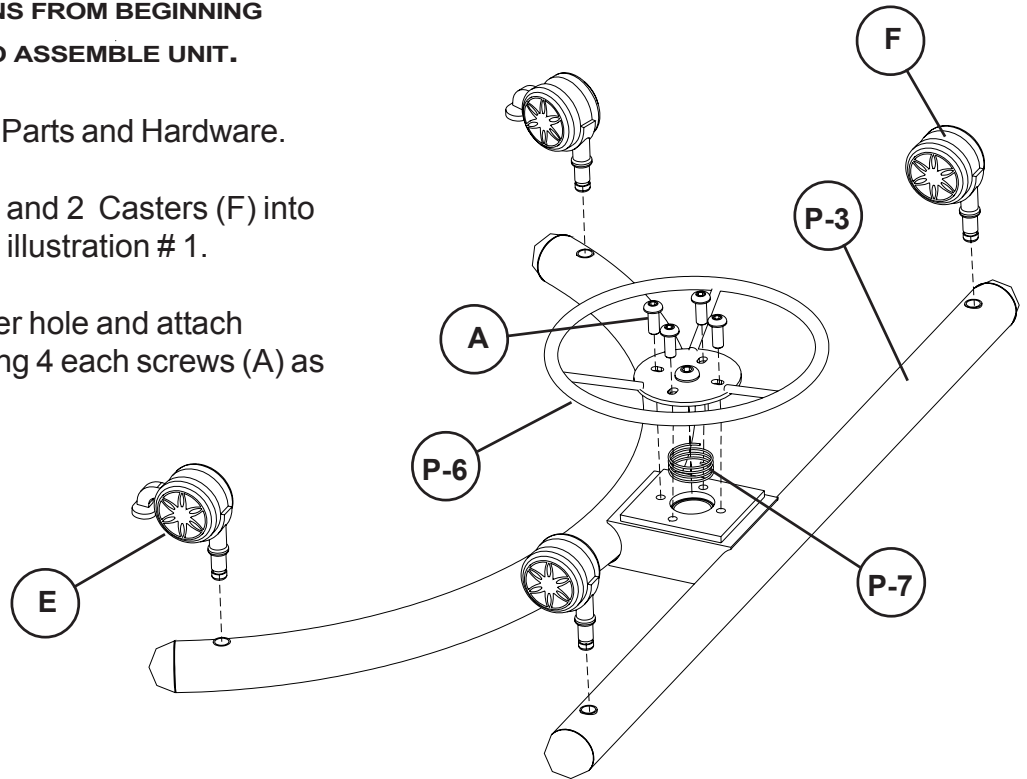

Illustration # 1

- 4.) Attach Pneumatic Cylinder (P-4) to the Leg Base (P-3) using 4 screws (A1) as shown in illustration #2.
- 5.) Tighten screws using Allen Wrench (G).

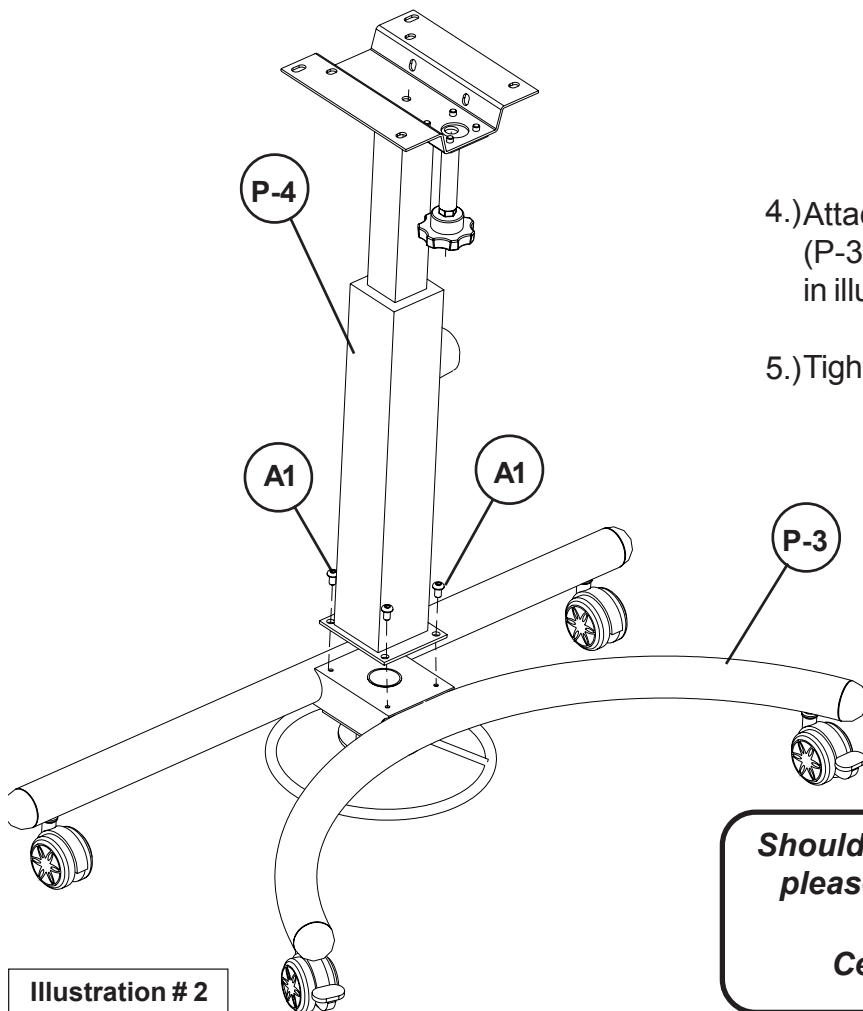
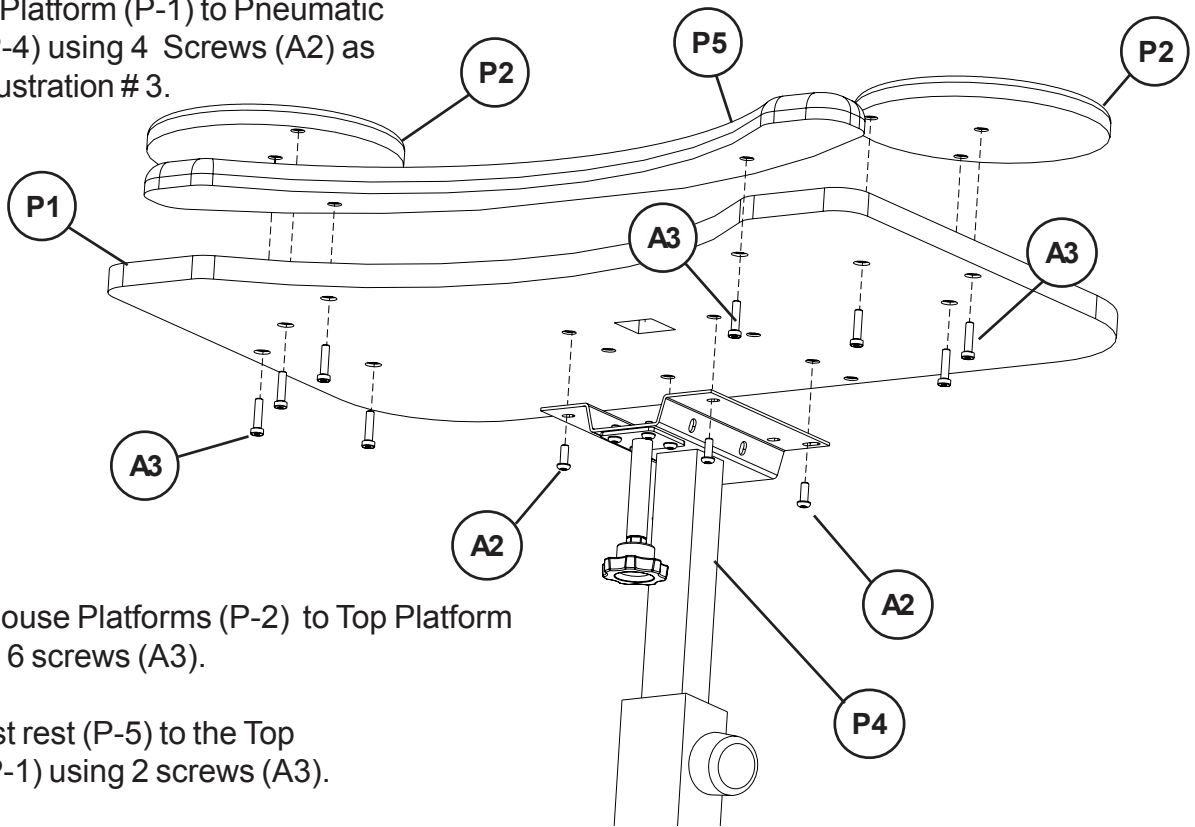

Illustration # 2

**Should you require assistance during assembly,
please call our Customer Service Department
Monday - Friday 8 a.m. - 5 p.m.
Central Standard Time 1-800-749-2258**

Illustration # 3

6.) Attach Top Platform (P-1) to Pneumatic Cylinder (P-4) using 4 Screws (A2) as shown in illustration # 3.



7.) Attach 2 Mouse Platforms (P-2) to Top Platform (P-1) using 6 screws (A3).

8.) Attach Wrist rest (P-5) to the Top Platform (P-1) using 2 screws (A3).

9.) Tighten screws using Allen Wrench (G).

10.) Insert Pivot Rod (D) through Top Platform (P-1) and attach to threaded Knob by turning 4 - 6 complete turns as shown in illustration # 4.

Illustration # 4

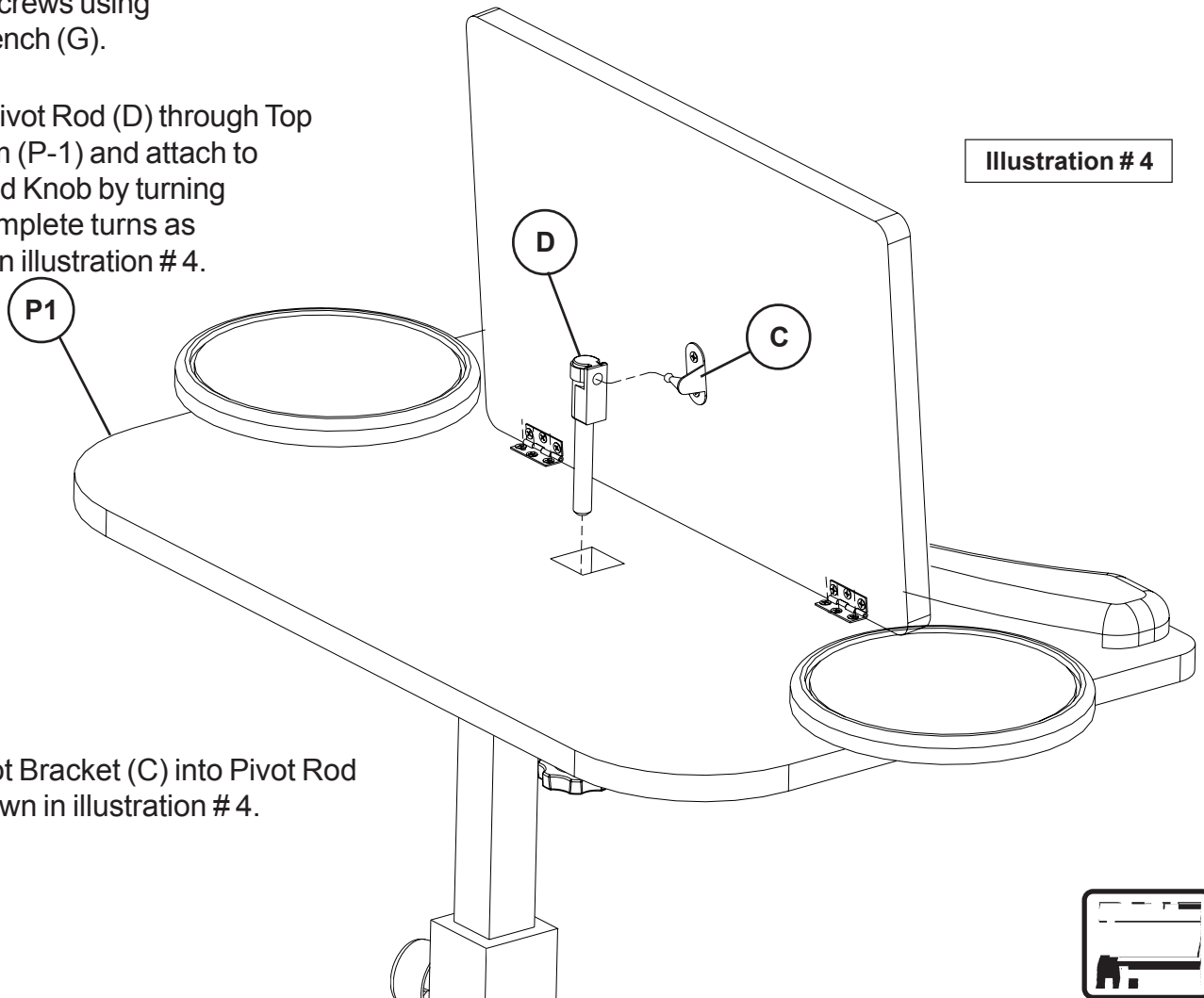

11.) Insert Pivot Bracket (C) into Pivot Rod (D) as shown in illustration # 4.



Pneumatic Cylinder Adjustment

Note: If Cylinder does not extend smoothly when you press (P6) Adjustment Wheel, turn adjustment screw to the right 1-2 turns.

If Cylinder does extend without pressing the (P6) Adjustment Wheel, turn adjustment screw to the left 1-2 turns.

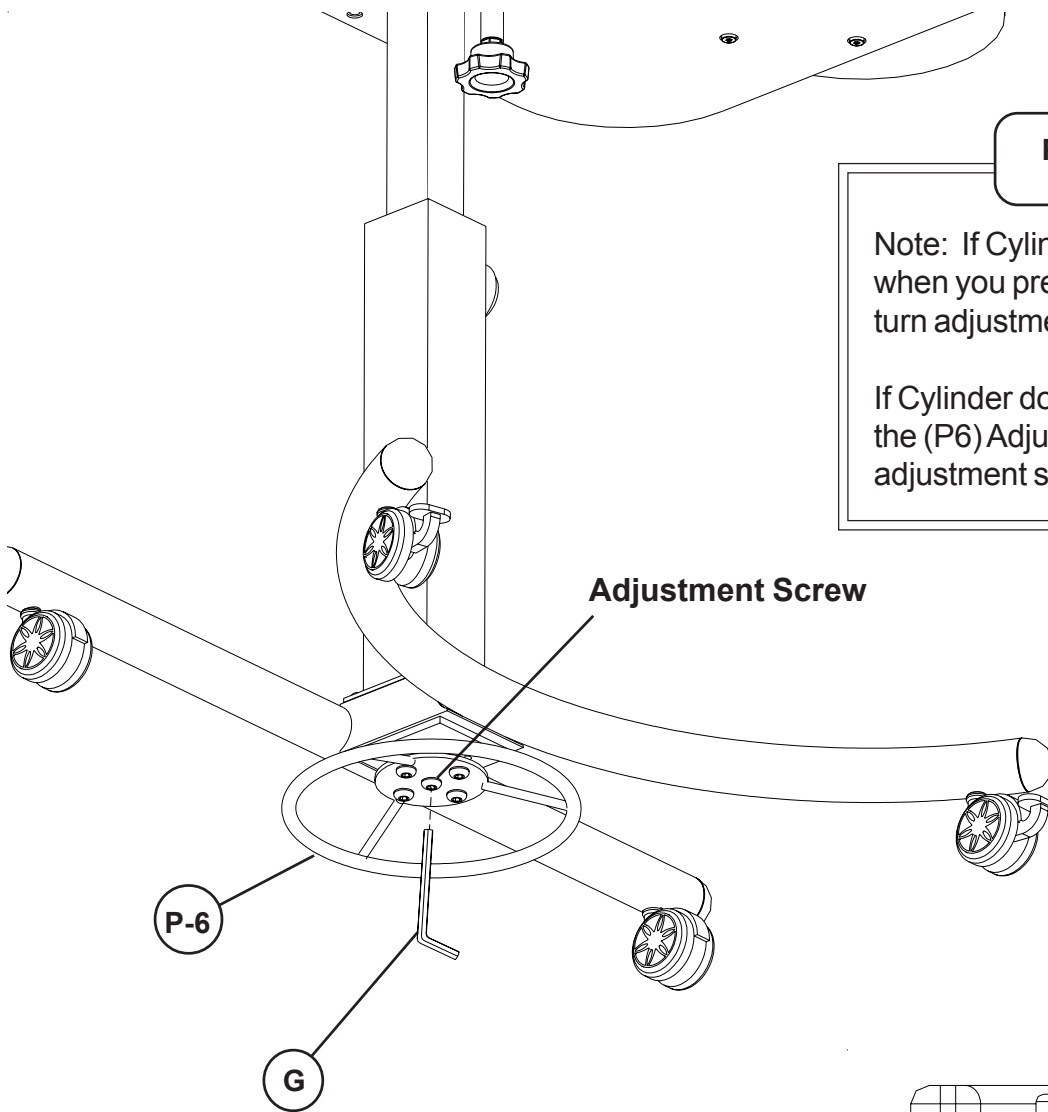

Height Adjustment

To raise height of platform, loosen adjustment knob (Y) and press Adjustment Wheel (P-7). The pneumatic cylinder will begin lifting the unit, and you can release Adjustment Wheel at the desired height. Secure platform at desired height by tightening adjustment knob (Y).

To lower height of platform, loosen adjustment knob (Y) and press Adjustment wheel (P-7). Press on center of Top Platform using body weight. Top Platform will lower and you can release Adjustment Wheel at the desired height. Secure platform at desired height by tightening adjustment knob (Y).

Turn Knob(X) to adjust angle of Keyboard Platform

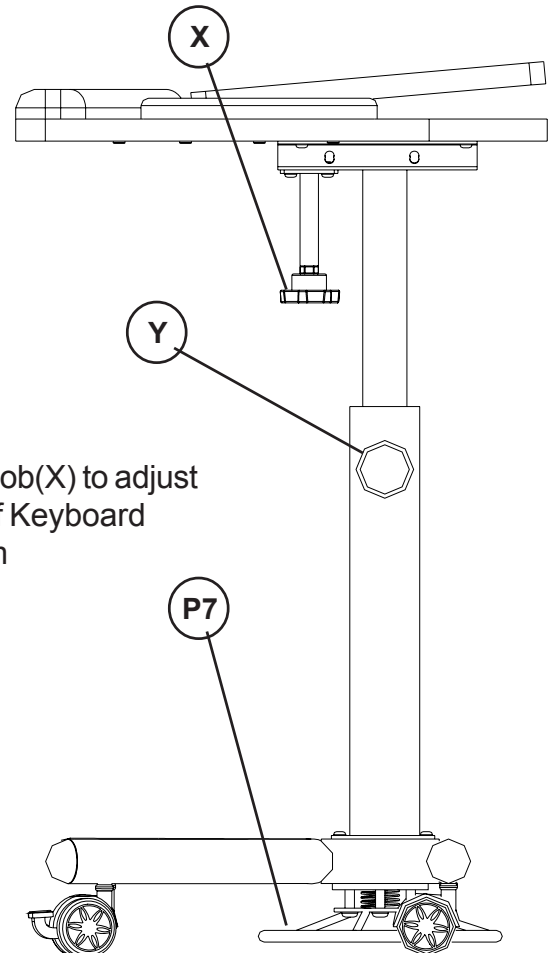

#89829 LapMatic Laptop/Keyboard Desk



For more information
1-800-749-2258

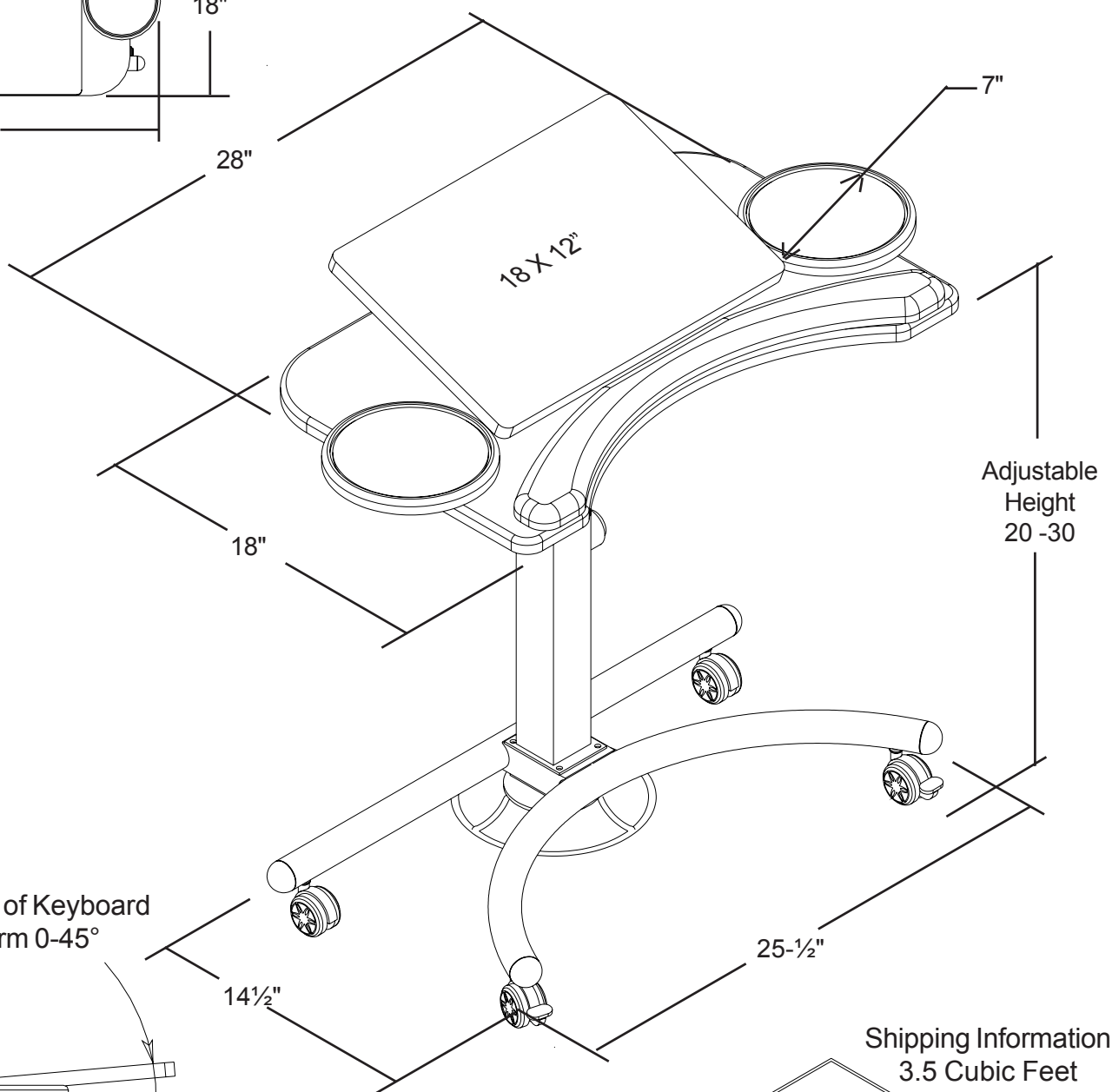
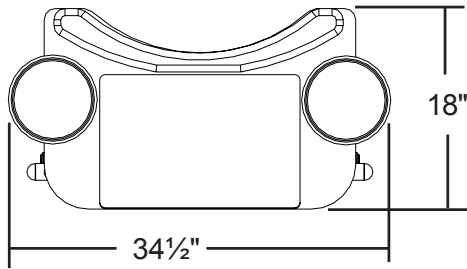

Angle of Keyboard Platform
0-45°

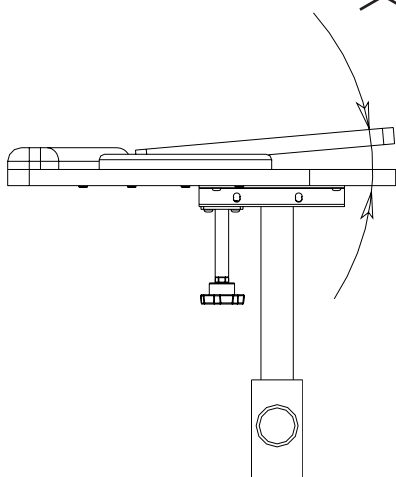

Shipping Information
3.5 Cubic Feet
38 lbs.

